

PM SERIES

U-shaped Micro Photoelectric Sensor

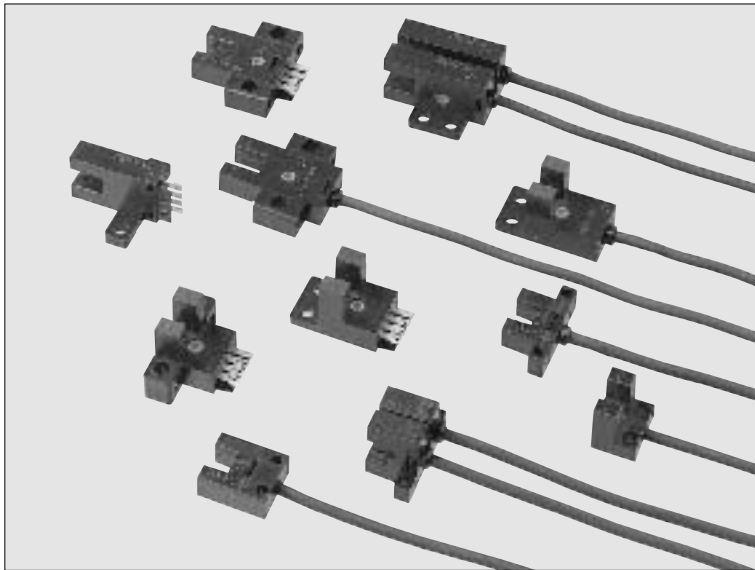

Extremely small size enables space saving and quick installation!



Extremely small

Ultra-small type **PM-□24(-R)** contributes to the miniaturization of your equipment. Even the small cable type has become very compact.

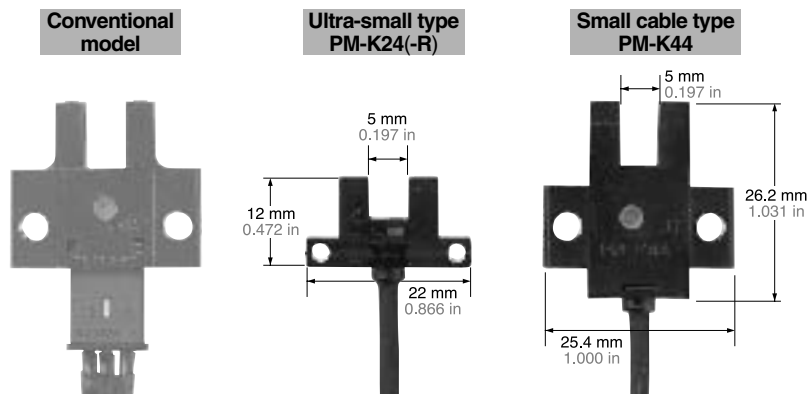

Equipped with two independent outputs

All models are equipped with two independent outputs – Light-ON and Dark-ON. Hence, one model suffices even if the output is to be used differently, depending upon the location of use.

Also, since two independent outputs have been provided, cumbersome handling of the output conversion control input, or fear of logic inversion due to a cable break, is eliminated. The sensor can be connected to the existing wiring as it is.

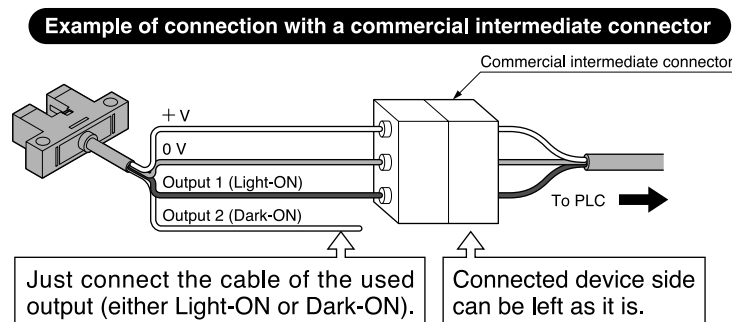

Note: Ensure to insulate the unused output wire.

Quick fitting hook-up connector

Easy to maintain connector type models are available. Its exclusive connector is the industry's first hook-up connector. Since only crimping with exclusive pliers is to be done, cumbersome soldering or insulation is absolutely not required. Further, connector attached cable is also available.

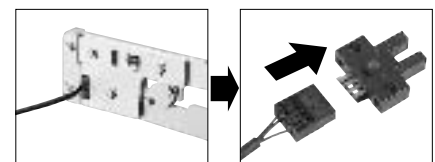

Crimp the connector on the cable.

Quick connection to the sensor.

Wide model variety

A wide variety of 17 shapes and 34 models is available. You may select from this wide range to suit the mounting conditions.

Meets global requirements

Conforms to Europe's EMC Directive and obtains UL Recognition. Both, NPN and PNP output models are available.

APPLICATIONS

Sensing the starting point on a rotating body

The starting point can be sensed by making a slit in the rotating body.

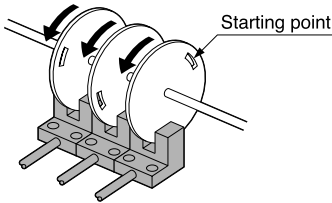

Determining the pallet position

Pallet is stopped by sensing the dog.

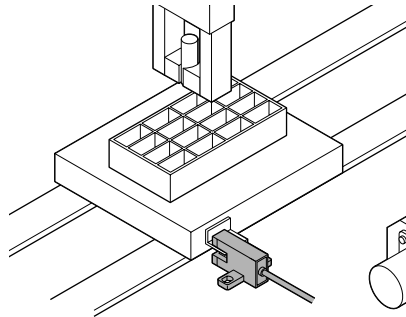

Sensing the starting point and overrun of a moving body

Starting point and overrun is sensed using the dog on the base.

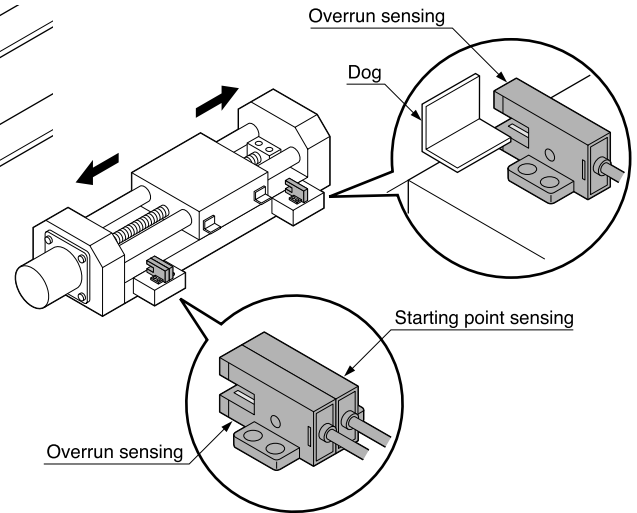

ORDER GUIDE

Type	Appearance (mm in)	Sensing range	Model No. (Note)	Output	Output operation
Ultra-small			PM-K24	NPN open-collector transistor	Incorporated with 2 outputs: Light-ON / Dark-ON
			PM-K24-R		
			PM-L24		
			PM-L24-R		
			PM-F24		
			PM-F24-R		
			PM-R24		
			PM-R24-R		
			PM-U24		
			PM-U24-R		

Note: The suffix '-R' indicates a flexible cable type.

ORDER GUIDE

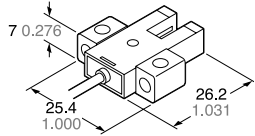
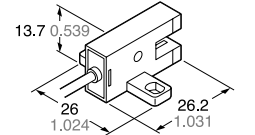
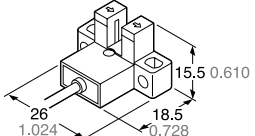
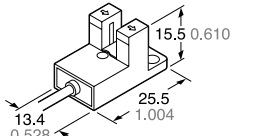
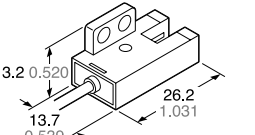
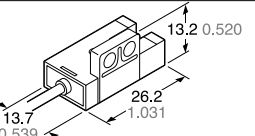
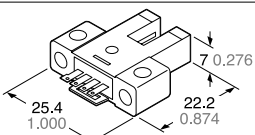
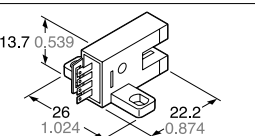
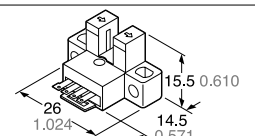
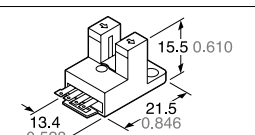
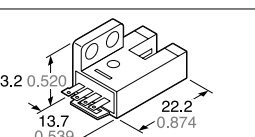
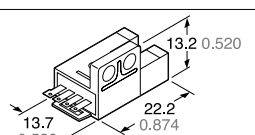
Type	Appearance (mm in)	Sensing range	Model No.	Output	Output operation		
Small	With cable	5 mm 0.197 in (fixed)	K type		PM-K44	NPN open-collector transistor	
					PM-K44P	PNP open-collector transistor	
			T type		PM-T44	NPN open-collector transistor	
					PM-T44P	PNP open-collector transistor	
			L type		PM-L44	NPN open-collector transistor	
					PM-L44P	PNP open-collector transistor	
			Y type		PM-Y44	NPN open-collector transistor	
				PM-Y44P	PNP open-collector transistor		
	F type			PM-F44	NPN open-collector transistor		
				PM-F44P	PNP open-collector transistor		
	R type			PM-R44	NPN open-collector transistor		
				PM-R44P	PNP open-collector transistor		
	With connector		K type		PM-K54	NPN open-collector transistor	Incorporated with 2 outputs: Light-ON / Dark-ON
					PM-K54P	PNP open-collector transistor	
T type			PM-T54	NPN open-collector transistor			
			PM-T54P	PNP open-collector transistor			
L type			PM-L54	NPN open-collector transistor			
			PM-L54P	PNP open-collector transistor			
Y type			PM-Y54	NPN open-collector transistor			
		PM-Y54P	PNP open-collector transistor				
F type		PM-F54	NPN open-collector transistor				
		PM-F54P	PNP open-collector transistor				
R type		PM-R54	NPN open-collector transistor				
		PM-R54P	PNP open-collector transistor				

ORDER GUIDE

3 m 9.843 ft cable length type

3 m 9.843 ft cable length type (standard : 1 m 3.281 ft) is also available.

• Table of Model Nos.

Type		Standard	3 m 9.843 ft cable length type	
Ultra-Small	K Type	PM-K24	PM-K24-C3	
	L Type	PM-L24	PM-L24-C3	
	F Type	PM-F24	PM-F24-C3	
	R Type	PM-R24	PM-R24-C3	
	U Type	PM-U24	PM-U24-C3	
Small With Cable	K Type	NPN out put	PM-K44	PM-K44-C3
		PNP out put	PM-K44P	PM-K44P-C3
	T Type	NPN out put	PM-T44	PM-T44-C3
		PNP out put	PM-T44P	PM-T44P-C3
	L Type	NPN out put	PM-L44	PM-L44-C3
		PNP out put	PM-L44P	PM-L44P-C3
	Y Type	NPN out put	PM-Y44	PM-Y44-C3
		PNP out put	PM-Y44P	PM-Y44P-C3
	F Type	NPN out put	PM-F44	PM-F44-C3
		PNP out put	PM-F44P	PM-F44P-C3
	R Type	NPN out put	PM-R44	PM-R44-C3
		PNP out put	PM-R44P	PM-R44P-C3

OPTIONS

Designation	Model No.	Description
Connector	CN-14	Connector for soldering
Hook-up connector	CN-14H	This connector can be hooked-up on 0.08 to 0.2 mm ² cable simply in one grip. Wire diameter: ϕ 0.7 to ϕ 1.2 mm ϕ 0.028 to ϕ 0.047 in
	CN-14H-2	Suitable for UL standard cable. This connector can be hooked-up on 0.18 to 0.22 mm ² cable simply in one grip. Wire diameter: ϕ 1.2 to ϕ 1.52 mm ϕ 0.047 to ϕ 0.060 in
Connector attached cable	CN-14H-C1	Length: 1 m 3.281 ft Weight: 20 g approx. For the connector type, with 0.18 mm ² 4-core cabtyre cable
	CN-14H-C3	Length: 3 m 9.843 ft Weight: 60 g approx. Cable diameter: ϕ 3.8 mm ϕ 0.150 in
Hook-up pliers	CN-HP	These are exclusive pliers for hook-up connectors CN-14H and CN-14H-2 .
Mounting screw	MS-M2	Mounting screw with washers for the ultra-small type sensor (50 pcs. lot). It can mount securely as it is spring washer attached.

Connector • CN-14

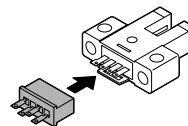

Hook-up connector • CN-14H • CN-14H-2

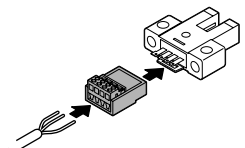

Connector attached cable • CN-14H-C1 • CN-14H-C3

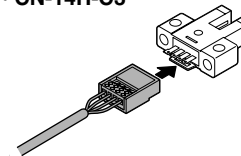

Hook-up pliers • CN-HP

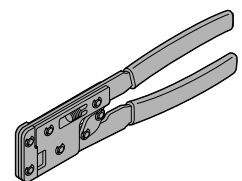

Mounting screw • MS-M2



SPECIFICATIONS

Item	Model No.	Type	Ultra-small		Small	
		NPN output type	PM-□24	With flexible cable	With cable	With connector
		PNP output type		PM-□24-R	PM-□44	PM-□54
					PM-□44P	PM-□54P
Sensing range			5 mm 0.197 in (fixed)			
Minimum sensing object			0.8 × 1.8 mm 0.031 × 0.071 in opaque object			
Hysteresis			0.05 mm 0.002 in or less			
Repeatability			0.03 mm 0.001 in or less			
Supply voltage			5 to 24 V DC ± 10 % Ripple P-P 10 % or less			
Current consumption			15 mA or less			
Output			<NPN output type> NPN open-collector transistor • Maximum sink current: 50 mA • Applied voltage: 30 V DC or less (between output and 0 V) • Residual voltage: 0.7 V or less (at 50 mA sink current) 0.4 V or less (at 16 mA sink current)		<PNP output type> PNP open-collector transistor • Maximum source current: 50 mA • Applied voltage: 30 V DC or less (between output and + V) • Residual voltage: 0.7 V or less (at 50 mA source current) 0.4 V or less (at 16 mA source current)	
Utilization category			DC-12 or DC-13			
Output operation			Incorporated with 2 outputs: Light-ON / Dark-ON			
Response time			Under light received condition: 20 μs or less Under light interrupted condition: 100 μs or less (Response frequency: 1 kHz or more)(Note 1)			
Operation indicator			Vermilion LED (lights up under light received condition)			
Environmental resistance	Pollution degree		3 (Industrial environment)			
	Ambient temperature (Note 2, 3)		- 25 to + 55 °C - 13 to + 131 °F (No dew condensation or icing allowed), Storage: - 30 to + 80 °C - 22 to + 176 °F			
	Ambient humidity		35 to 85 % RH, Storage: 35 to 85 % RH			
	Ambient illuminance		Fluorescent light: 1,000 lx at the light-receiving face			
	EMC		EN 50081-2, EN 50082-2, EN 60947-5-2			
	Voltage withstandability		1,000 V AC for one min. between all supply terminals connected together and enclosure			
	Insulation resistance		50 MΩ, or more, with 250 V DC megger between all supply terminals connected together and enclosure			
	Vibration resistance		10 to 2,000 Hz frequency, 1.5 mm 0.059 in amplitude in X, Y and Z directions for two hours each			
Shock resistance		15,000 m/s ² acceleration (1,500 G approx.) in X, Y and Z directions for three times each				
Emitting element			Infrared LED (non-modulated)			
Material			Enclosure: PBT, Slit cover: Polycarbonate, Terminal part [PM-□54(P) only]: Solder plated			
Cable			0.09 mm ² 4-core cabtyre cable [PM-□24-R: 0.1 mm ² flexible, oil and heat resistant cabtyre cable (Note 4)], 1 m 3.281 ft long			
Cable extension			Extension up to total 100 m 328.084 ft is possible with 0.3 mm ² , or more, cable.			
Weight			10 g approx.		15 g approx. 3 g approx.	

Notes: 1) The response frequency is the value when the disc, given in the figure below, is rotated.

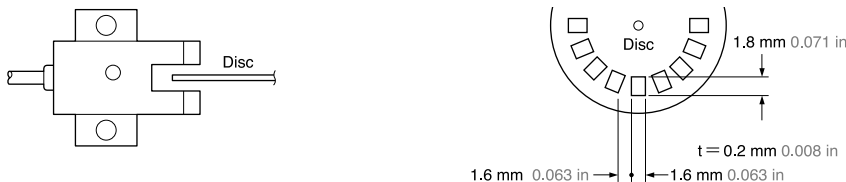

- 2) In case the ultra-small type **PM-□24-R** is used at an ambient temperature of + 50 °C + 122 °F, or more, make sure to mount it on a metal body.
- 3) Take care that the flexibility of the **PM-□24-R** cable is lost if the ambient temperature is near - 10 °C + 14 °F.
- 4) The cable of **PM-□24-R** is a flexible cable usable on a moving base. When the sensor is mounted on a moving base, fix the sensor cable joint so that stress is not applied to it.

I/O CIRCUIT AND WIRING DIAGRAMS

PM-□24 PM-□24-R
PM-□44 PM-□54

NPN output type

I/O circuit diagram

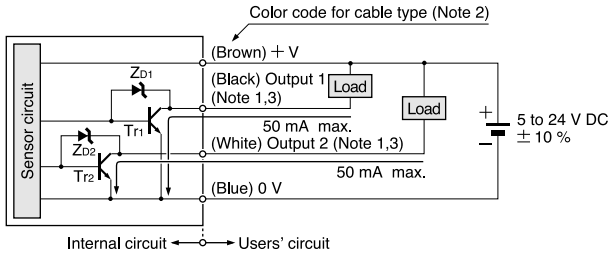

Wiring diagram

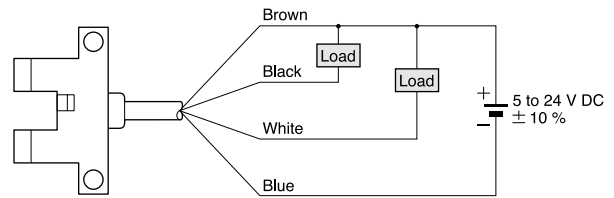

- Notes: 1) Make sure to connect terminals correctly as the sensor does not incorporate a reverse polarity protection circuit. Further, the output is not incorporated with a short-circuit protection circuit. Do not connect it directly to a power supply or a capacitive load. Faulty wiring may result in damage.
2) The color code of the connector attached cable is also the same.
3) Ensure to insulate the unused output wire.

Output operation

	Color code	Output operation
Output 1	Black	Light-ON
Output 2	White	Dark-ON

Symbols ... Zd1, Zd2: Surge absorption zener diode
Tr1, Tr2 : NPN output transistor

PM-□44P
PM-□54P

PNP output type

I/O circuit diagram

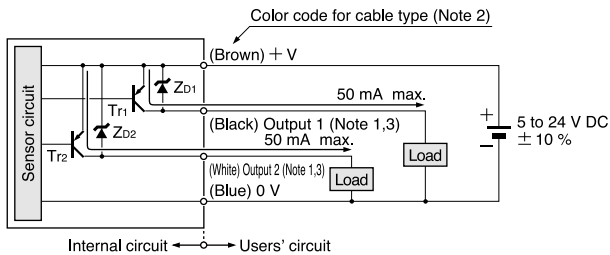

Wiring diagram

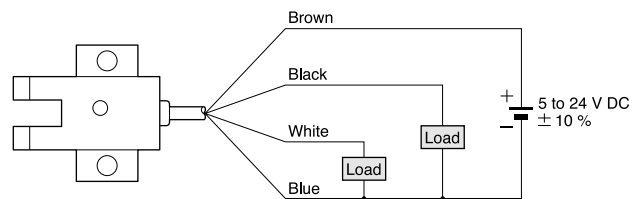

- Notes: 1) Make sure to connect terminals correctly as the sensor does not incorporate a reverse polarity protection circuit. Further, the output is not incorporated with a short-circuit protection circuit. Do not connect it directly to a power supply or a capacitive load. Faulty wiring may result in damage.
2) The color code of the connector attached cable is also the same.
3) Ensure to insulate the unused output wire.

Output operation

	Color code	Output operation
Output 1	Black	Light-ON
Output 2	White	Dark-ON

Symbols ... Zd1, Zd2: Surge absorption zener diode
Tr1, Tr2 : PNP output transistor

SENSING CHARACTERISTICS (TYPICAL)

PM-24□(-R)

Ultra small type

Sensing position

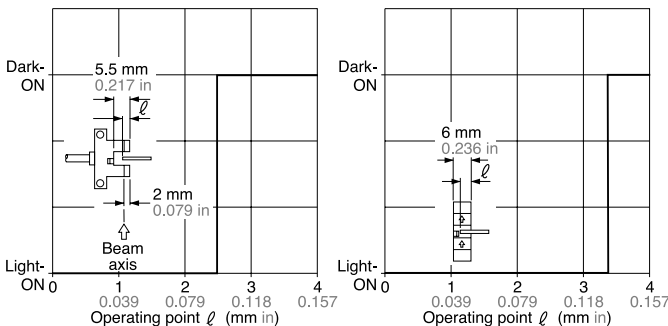

PM-□44(P)
PM-□54(P)

Small type

Sensing position

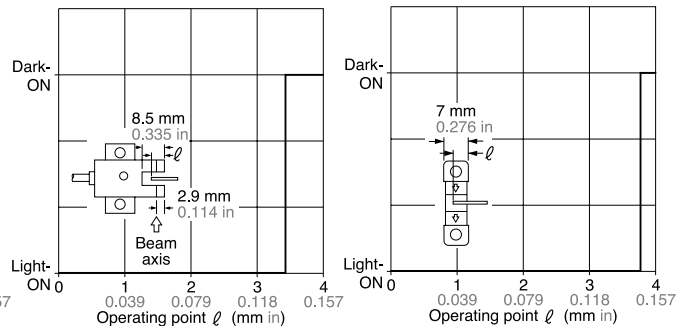

PRECAUTIONS FOR PROPER USE

All models



This product is not a safety sensor. Its use is not intended or designed to protect life and prevent body injury or property damage from dangerous parts of machinery. It is a normal object detection sensor.



Make sure to connect terminals correctly as the sensor does not incorporate a reverse polarity protection circuit. Further, the output is not incorporated with a short-circuit protection circuit. Do not connect it directly to a power supply or a capacitive load. Faulty wiring may result in damage.

Others

- Since the sensor is intended for use inside machines, no special counter-measures have been taken against extraneous light. Take care that extraneous light is not directly incident on the beam receiving section.
- Do not use during the initial transient time (50 ms) after the power supply is switched on.
- The cable of **PM-□24-R** is a flexible cable usable on a moving base. When the sensor is mounted on a moving base, fix the sensor cable joint so that stress is not applied to it.
- Take care that the flexibility of the **PM-□24-R** cable is lost if the ambient temperature is near $-10\text{ }^{\circ}\text{C}$ $+14\text{ }^{\circ}\text{F}$.

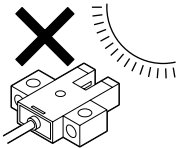

Mounting

- When fixing the sensor with screws, use M3 screws [M2 screws in case of **PM-□24(-R)**] and the tightening torque should not exceed the values given below. Further, use small, round type plain washers. (M3: $\phi 6\text{ mm}$ $\phi 0.236\text{ in}$, M2: $\phi 4.3\text{ mm}$ $\phi 0.169\text{ in}$)

Model No.	Tightening torque
PM-□24(-R)	0.15 N·m
PM-□44(P)	0.5 N·m
PM-□54(P)	

Note: In case the ultra-small type **PM-□24(-R)** is used at an ambient temperature of $+50\text{ }^{\circ}\text{C}$ $+122\text{ }^{\circ}\text{F}$, or more, make sure to mount it on a metal body.

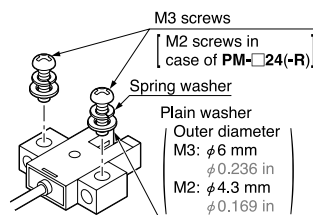

Cable extension

- Cable extension is possible up to an overall length of 100 m 328.084 ft with a 0.3 mm^2 , or more, cable. However, since a voltage drop shall occur due to the cable extension, ensure that the power supply voltage at the end of the cable attached to the sensor or at the sensor terminals is within the rating.

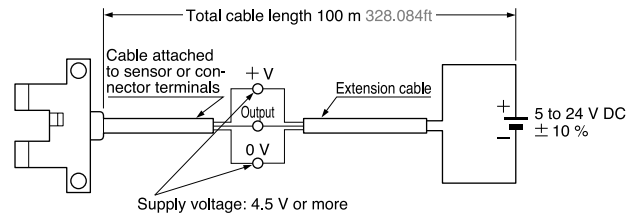

But, when the overall cable length, including the cable attached to the sensor, is as given below, there is no need to confirm the voltage.

Conductor cross-section area	Total cable length
0.08 to 0.1 mm^2	Up to 5 m 16.404 ft
0.2 mm^2	Up to 10 m 32.808 ft
0.3 mm^2	Up to 20 m 65.617 ft

PRECAUTIONS FOR PROPER USE

PM-□54
PM-□54P

Cautions in plugging or unplugging a connector



- Do not plug or unplug a connector more than 10 times.
- Be sure not to give stress more than 5 N to a terminal of both a connector and a sensor. If you do not follow the above cautions, it will cause a poor contact.

Procedures of plugging or unplugging a connector

- ① Insert a connector straight into a sensor until the connector lug is locked by the sensor hook.

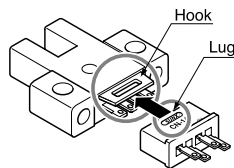

- ② When unplugging, give as much stress as a connector lug can be relieved from a hook. Then unplug it.

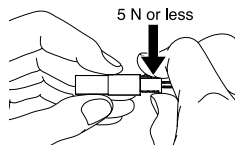

Caution: Be sure to hold a connector when plugging or unplugging it. Do not hold a terminal or a cable when plugging or unplugging the connector. Otherwise, it will cause a poor contact.

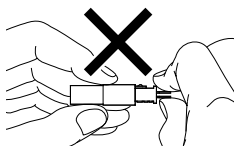

Crimping of hook-up connectors CN-14H and CN-14H-2

Item	Model No. CN-14H	CN-14H-2
Conductor cross-section area	0.08 to 0.2 mm ² (AWG28 to AWG24)	0.18 to 0.22 mm ² (AWG25 to AWG24)
Wire diameter	φ 0.7 to φ 1.2 mm φ 0.028 to φ 0.047 in	φ 1.2 to φ 1.52 mm φ 0.047 to φ 0.060 in
Wire insulation material	Vinyl chloride or soft polyethylene	

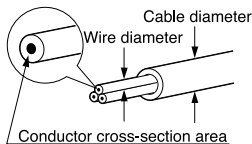

Crimping method

- ① Strip the cable sheath 15 mm 0.591 in, or more, and insert the wires into the connector insertion holes till the wire tips reach the end.

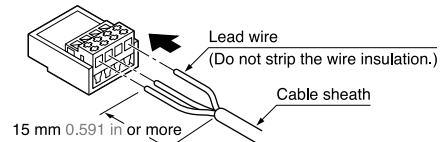

Arrangement of connector terminals

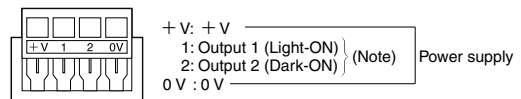

Note: Wire at Pin No.1 or 2 as per requirement.

- ② Crimp with the exclusive hook-up pliers **CN-HP**.

- Notes: 1) When attaching or detaching the connector fitted with a cable, make sure to hold the connector firmly before proceeding.
2) After crimping, do not pull on the cable.

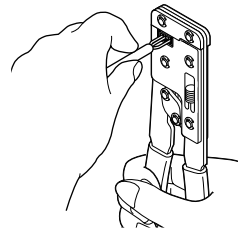

Caution: Make sure to use the exclusive hook-up pliers **CN-HP**. Commercially available pliers cannot be used.

- Prior to using the sensor, affix the cable in a way as to avoid direct stress on the crimped part.

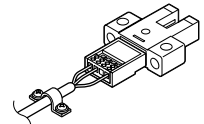

Soldering (Both connector CN-14 and sensor)

- If soldering is done directly on the terminals, strictly adhere to the conditions given below.

Soldering temperature	260 °C 500 °F or less
Soldering time	3 sec. or less
Soldering position	Refer to the below figure

Sensor

Connector

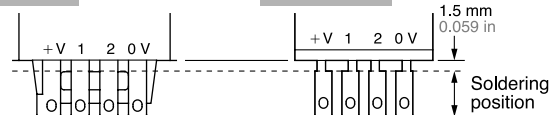

PM

DIMENSIONS (Unit: mm in)

**PM-K24
PM-K24-R** Sensor

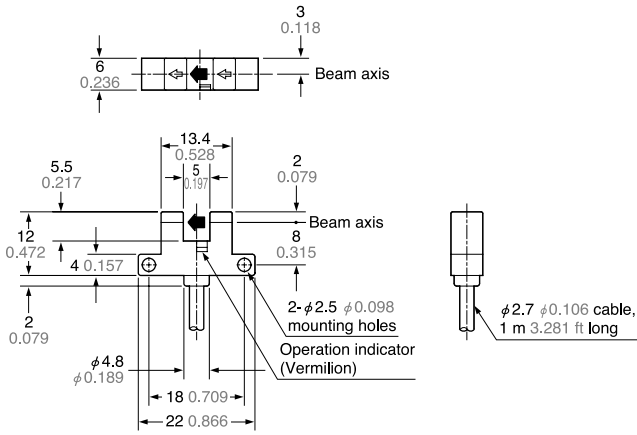

**PM-L24
PM-L24-R** Sensor

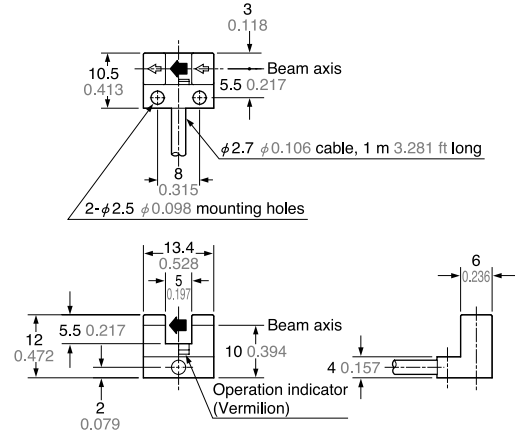

**PM-F24
PM-F24-R** Sensor

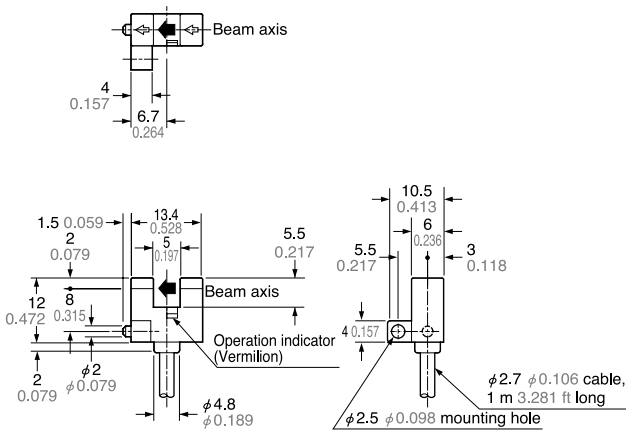

**PM-R24
PM-R24-R** Sensor

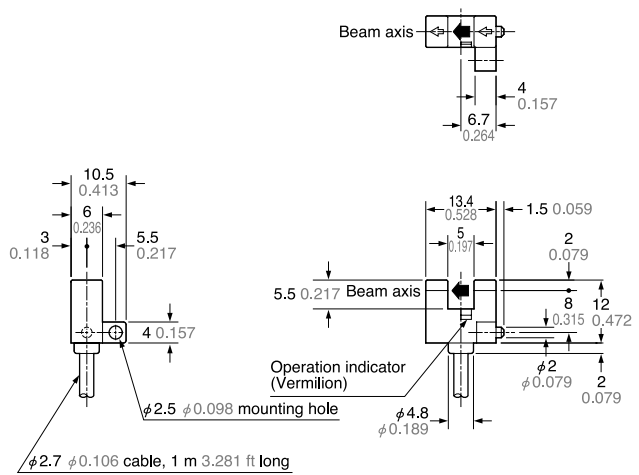

**PM-U24
PM-U24-R** Sensor

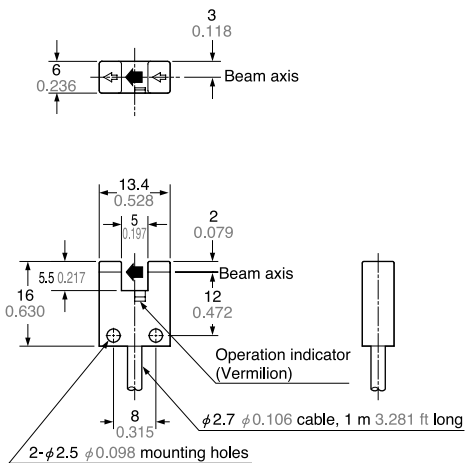

**PM-K44
PM-K44P** Sensor

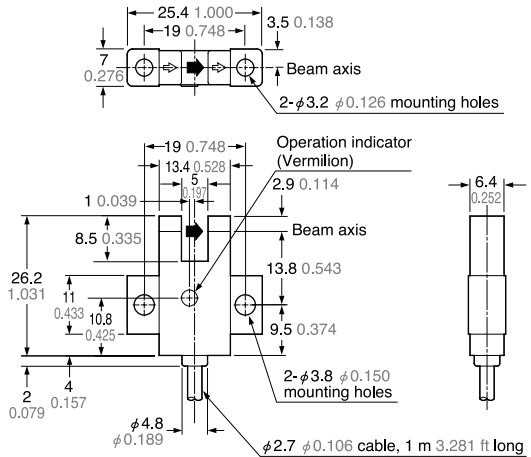

DIMENSIONS (Unit: mm in)

**PM-T44
PM-T44P** Sensor

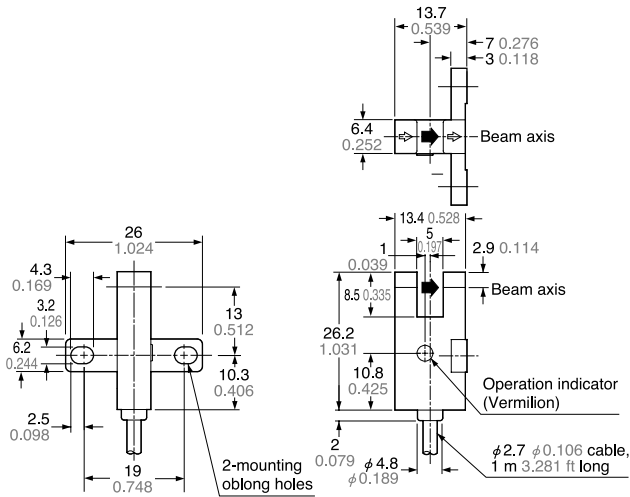

**PM-L44
PM-L44P** Sensor

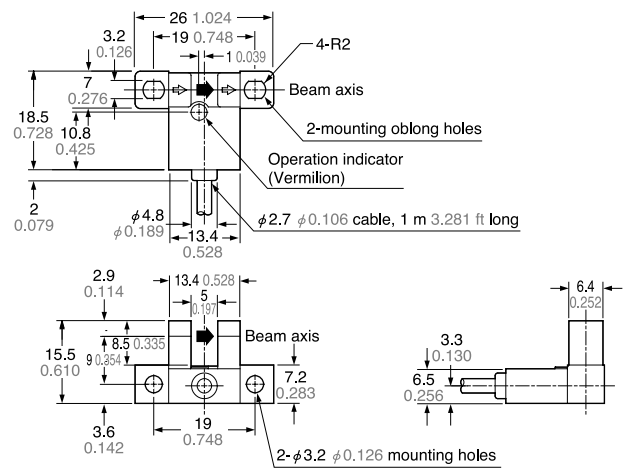

**PM-Y44
PM-Y44P** Sensor

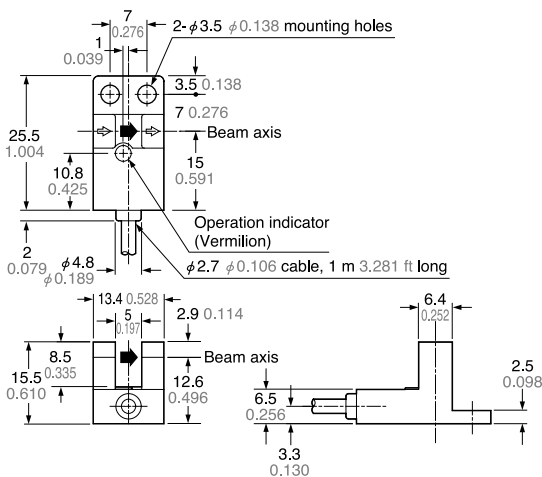

**PM-F44
PM-F44P** Sensor

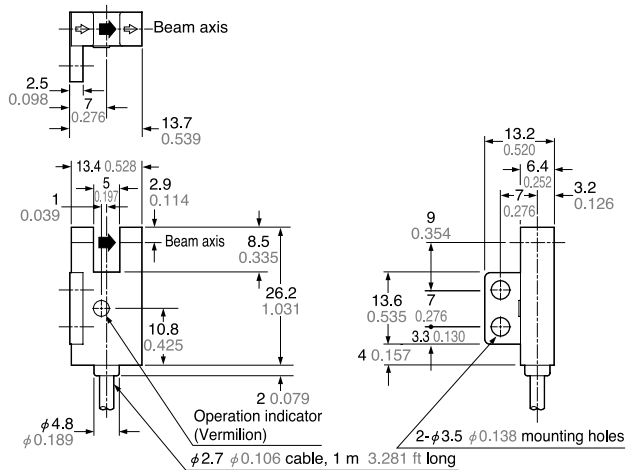

**PM-R44
PM-R44P** Sensor

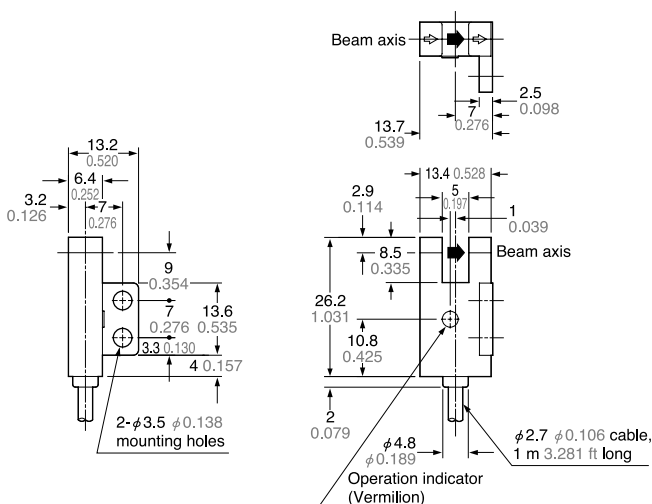

**PM-K54
PM-K54P** Sensor

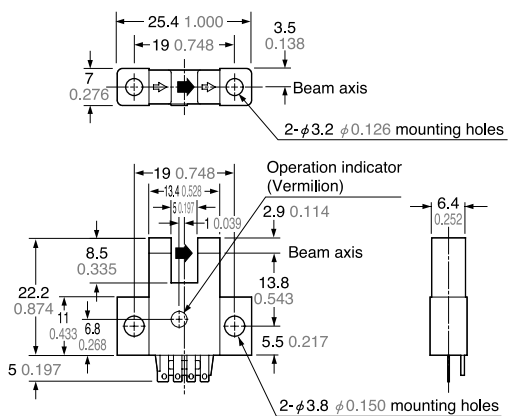

PM

DIMENSIONS (Unit: mm in)

**PM-T54
PM-T54P** Sensor

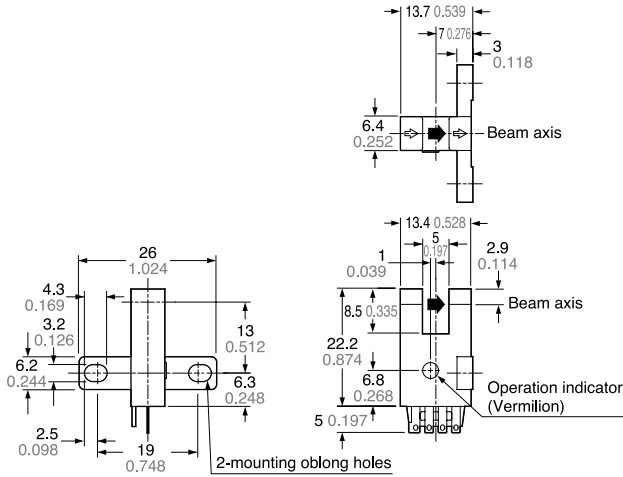

**PM-L54
PM-L54P** Sensor

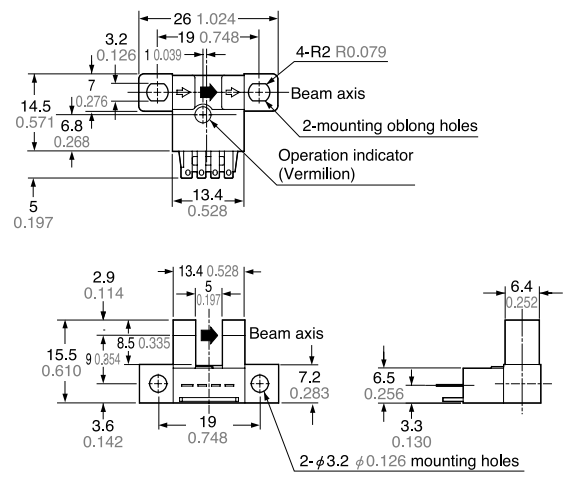

**PM-Y54
PM-Y54P** Sensor

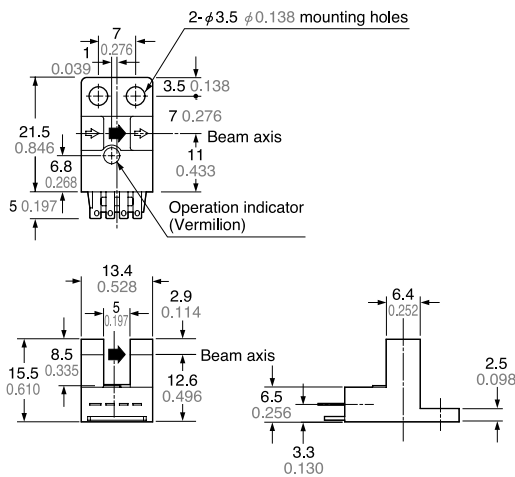

**PM-F54
PM-F54P** Sensor

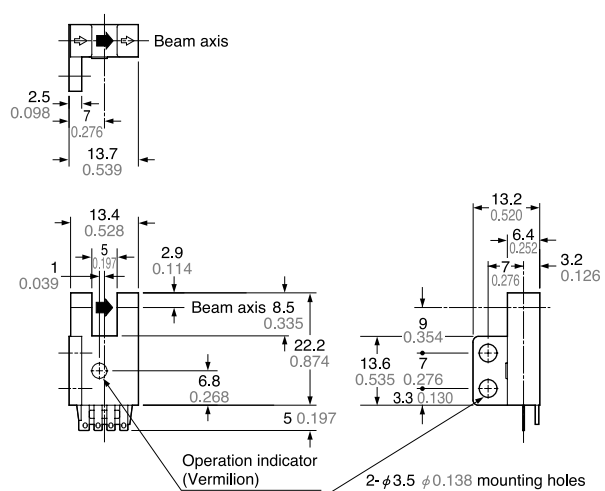

**PM-R54
PM-R54P** Sensor

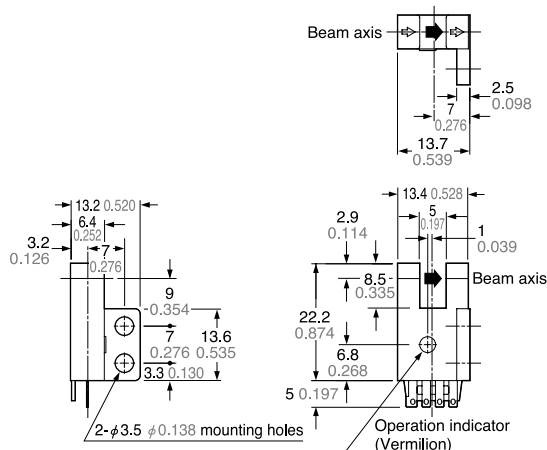

※Terminal part (PM-□54, PM-□54P)

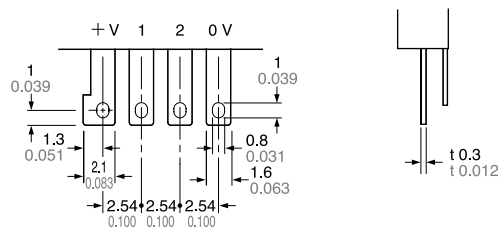

DIMENSIONS (Unit: mm in)

CN-14

Connector (Optional)

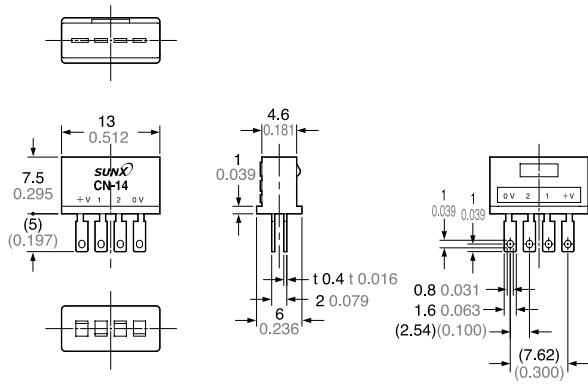

CN-14H CN-14H-2

Hook-up connector (Optional)

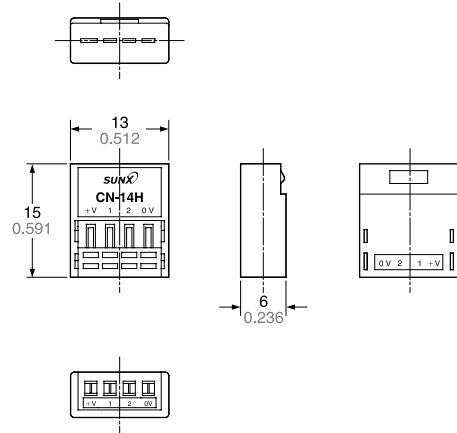

CN-14H-C1 CN-14H-C3

Connector attached cable (Optional)

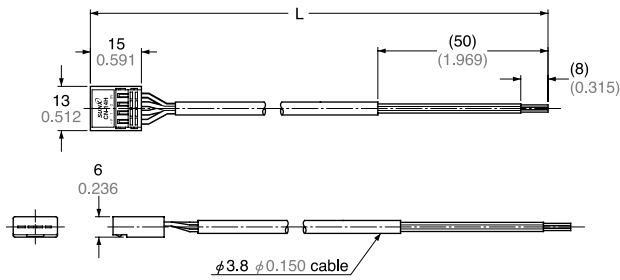

• Cable length L

Model No.	Cable length
CN-14H-C1	1 m 3.281 ft
CN-14H-C3	3 m 9.843 ft